

Karran Edge Series stainless steel sinks are manufactured from durable 18 gauge stainless steel that makes them tough and resilient to even the toughest daily tasks. Each Edge sink has a patented resin matrix rim that allows it to be seamlessly integrated into all laminate and solid surface countertop materials. Seamless integration is the most hygienic way to install a sink into a countertop in both residential and commercial applications.

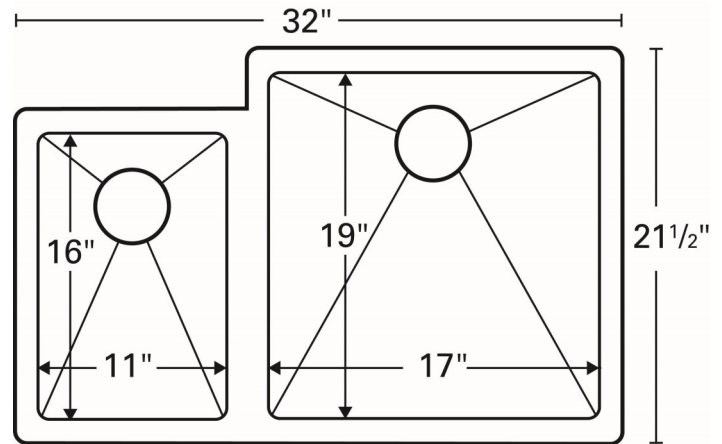

Series:	Edge 500 Series
Material:	18 Gauge, Type 304 stainless steel
Installation Type:	Seamless undermount
Configuration / Style:	Large/small bowl sink
Finish:	Soft satin brushed finish
Overall dimensions:	32" x 21-1/2"
Left bowl dimensions:	11" x 16" x 9"
Right bowl dimensions:	17" x 19" x 9"
Drain size:	3-1/2"
Min. cabinet size:	36"
Template included:	No
Clips included:	No
Accessories included:	No



INSTALLATION OPTIONS

IN LAMINATE

IN SOLID SURFACE

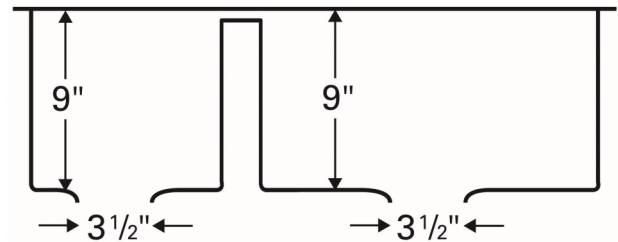
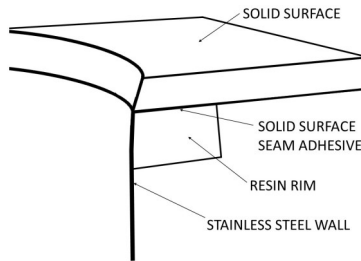
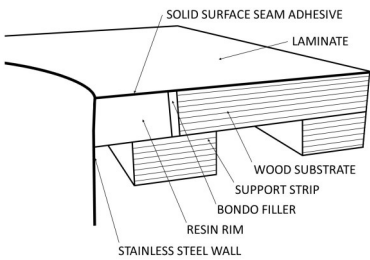

PROJECT INFORMATION

PROJECT: _____
CONTACT: _____
DATE: _____
NOTES: _____

APPROVAL: _____

RECOMMENDED TOOLING FOR INSTALLATION

- 10° Bevel bit [BITLAM]-Laminate installs
- 24° Bevel bit [BITSS24]-Solid surface Installs
- Seam adhesive [BRISA]
- Adhesive gun [AG]
- Non-woven flap wheel [FLAP3X2FINE]

OPTIONAL ACCESSORIES

- Stainless steel basket strainer [L-1]
- Stainless steel basket strainer [L-2]
- Stainless steel disposal flange [L-2DF]
- Sink grids [GR-1005, GR-1006]

We reserve the right to update product specifications without notice. Please visit karran.com for the most current specification sheets. All dimensions are accurate to 1/4". REV 05-2022