

This Karran Profile Series stainless steel kitchen sinks is manufactured from durable 16 gauge stainless steel that makes it tough and resilient to even the toughest daily tasks. Each sink is finished with an elegant soft satin brushed finish that resists and disguises surface scratches. Designed to be undermounted in all types of solid surface, granite and quartz countertops.

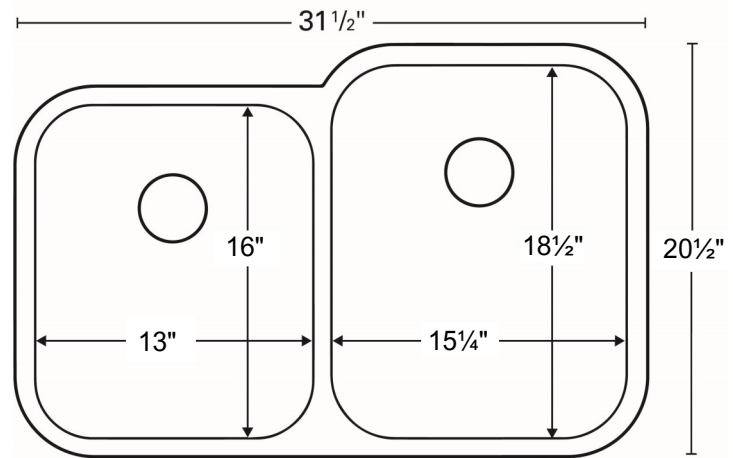

Series:	Profile Series
Material:	16 Gauge, Type 304 stainless steel
Installation Type:	Undermount
Configuration / Style:	Large/small bowl
Finish:	Soft satin brushed finish
Overall dimensions:	31-1/2" x 20-1/2"
Left bowl dimensions:	13" x 16" x 7-1/2"
Right bowl dimensions:	15-1/4" x 18-1/2" x 8-1/2"
Drain size:	3-1/2"
Min. cabinet size:	36"
Template included:	Yes
Clips included:	Yes
Accessories included:	None



INSTALLATION PROFILE

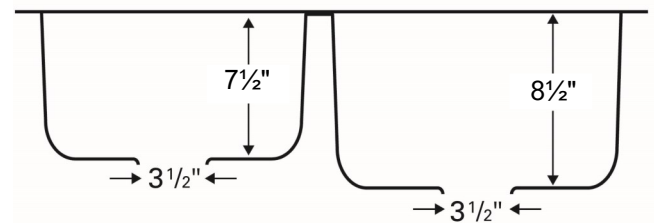
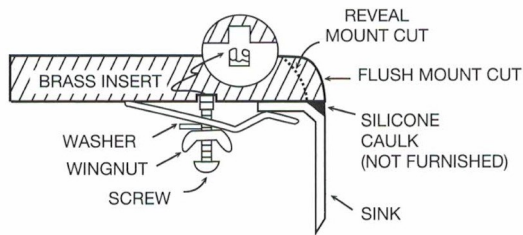

PROJECT INFORMATION

PROJECT: _____

CONTACT: _____

DATE: _____

NOTES: _____

APPROVAL:

OPTIONAL ACCESSORIES

- Stainless steel basket strainers [L-1]
- Stainless steel basket strainers [L-2]
- Stainless steel disposal flanges [L-2DF]
- Stainless steel bottom grids [GR-3009, GR-3010]

We reserve the right to update product specifications without notice. Please visit karran.com for the most current specification sheets. All dimensions are accurate to 1/4". REV 05-2022